

GROUP 22 - WHEELS

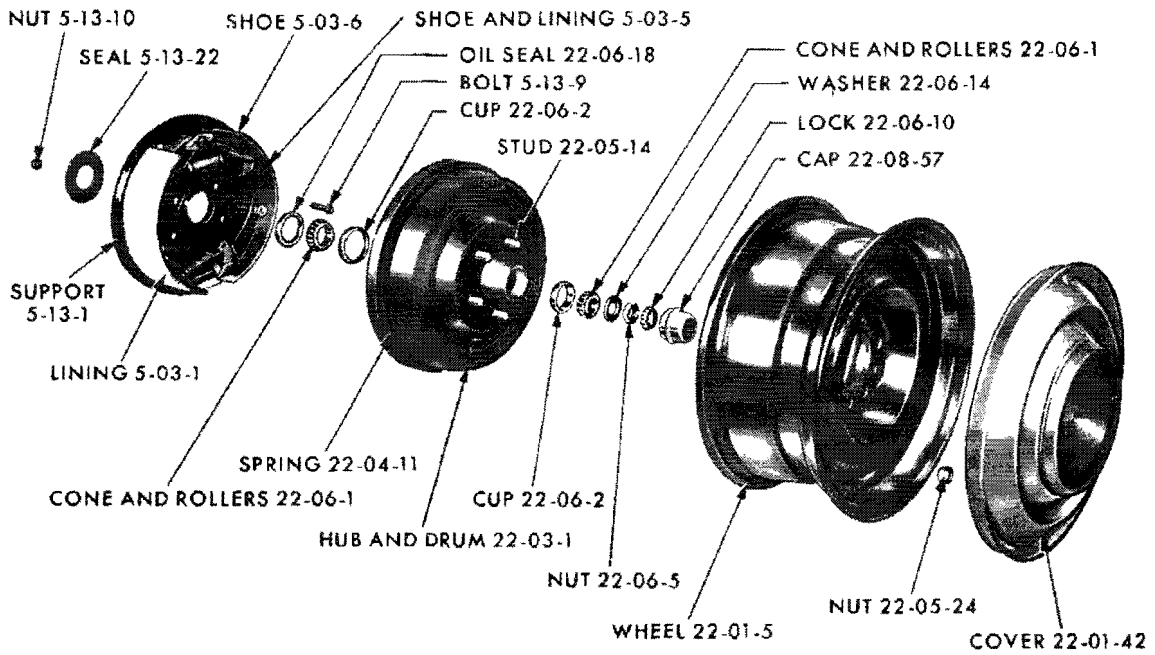

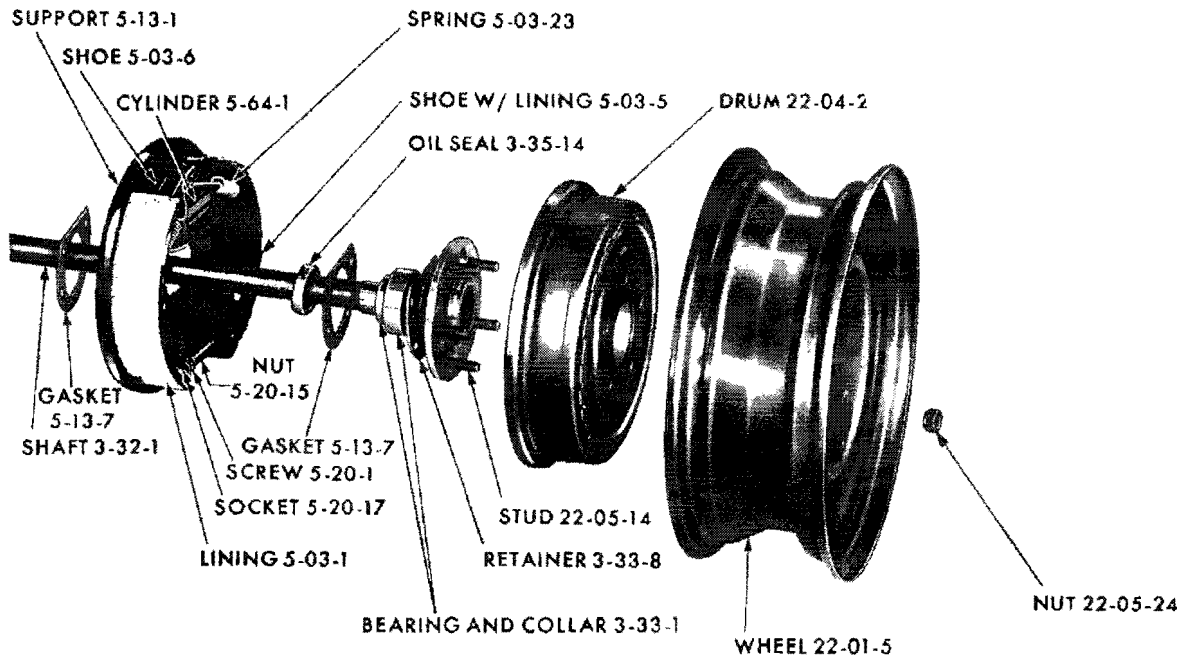

19x9691

FRONT WHEEL

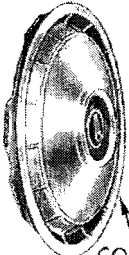
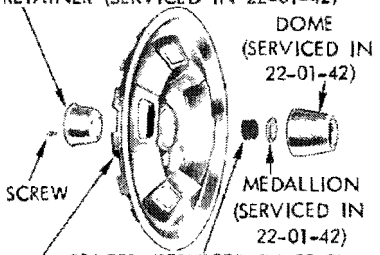

19x8787 D

REAR WHEEL

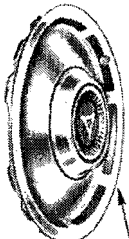
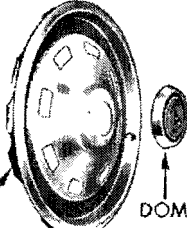
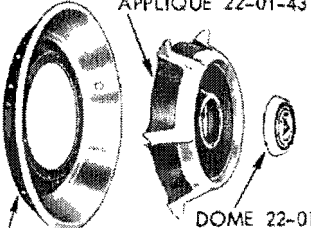
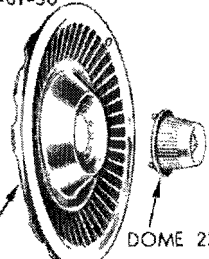
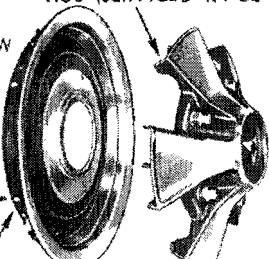
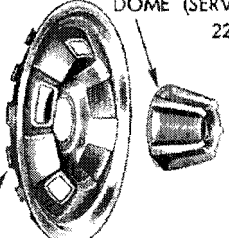
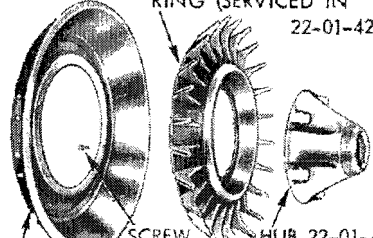
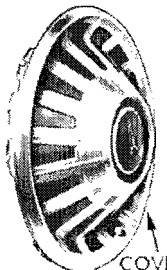
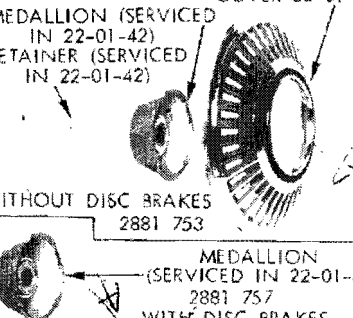
|  |   |  |  |
|--|---|--|--|
|  <p>COVER 22-01-42<br/>2781 550<br/>VALIANT</p>                           |  <p>RETAINER (SERVICED IN 22-01-42)<br/>SCREW<br/>DOME (SERVICED IN 22-01-42)<br/>MEDALLION (SERVICED IN 22-01-42)<br/>SPACER (SERVICED IN 22-01-42)<br/>COVER (SERVICED IN 22-01-42)<br/>2823 014<br/>VALIANT DELUXE AND BARRACUDA</p> |  <p>COVER 22-01-42<br/>2823 010<br/>VALIANT, BARRACUDA, BELVEDERE</p>                     |  <p>COVER 22-01-42<br/>2823 016<br/>DART</p>  |
|  <p>COVER (SERVICED IN 22-01-42)<br/>2823 024<br/>DART AND CORONET</p>    |  <p>APPLIQUE 22-01-43<br/>COVER (SERVICED IN 22-01-42)<br/>DOME 22-01-51<br/>2880 621<br/>CHARGER AND DODGE</p>  |  <p>SPRING 22-01-58<br/>SCREW<br/>COVER (SERVICED IN 22-01-42)<br/>2823 004<br/>DODGE</p> |  <p>HUB (SERVICED IN 22-01-42)<br/>SCREW<br/>COVER (SERVICED IN 22-01-42)<br/>2808 349<br/>DODGE "MAG"</p>  |
|  <p>COVER (SERVICED IN 22-01-42)<br/>2823 028<br/>BELVEDERE-PLYMOUTH</p> |  <p>RING (SERVICED IN 22-01-42)<br/>SCREW<br/>HUB 22-01-43<br/>COVER (SERVICED IN 22-01-42)<br/>2660 971<br/>FURY</p>  |  <p>COVER 22-01-42<br/>2823 029<br/>PLYMOUTH</p>   |  <p>COVER 22-01-42<br/>MEDALLION (SERVICED IN 22-01-42)<br/>RETAINER (SERVICED IN 22-01-42)<br/>WITHOUT DISC BRAKES<br/>2881 753<br/>MEDALLION (SERVICED IN 22-01-42)<br/>2881 757<br/>WITH DISC BRAKES<br/>PLYMOUTH, DODGE AND CHRYSLER</p> |

WHEEL COVERS

19a0937A

22-01-0 WHEELS

TIRE CHART

| Wheel Size | Tire Size                                     |
|------------|---|
| 13 x 4.50  | 6.50 x 13 - 7.00 x 13                         |
| 14 x 4.50  | 6.95 x 14                                     |
| 14 x 5.00  | 6.50 x 14 - 7.00 x 14 - 7.35 x 14             |
|            | 7.50 x 14 - 7.75 x 14                         |
| 14 x 5.50  | 6.95 x 14 - 7.00 x 14 - 7.50 x 14 - 7.75 x 14 |
|            | 8.00 x 14 - 8.25 x 14                         |
| 14 x 6.00  | 8.00 x 14 - 8.25 x 14 - 8.50 x 14 - 8.55 x 14 |
| 14 x 6.50  | 8.85 x 14 - 9.00 x 14                         |
| 15 x 5.50  | 6.70 x 15                                     |
| 15 x 6.00  | 7.60 x 15                                     |
| 15 x 6.00  | 7.35 x 15 - 7.60 x 15 - 8.00 x 15 - 8.20 x 15 |
|            | 8.45 x 15 - 8.85 x 15 - 9.15 x 15             |

| CODE     | PART NAME AND DESCRIPTION                                     | CYL | PER CAR | VALIANT<br>BARRACUDA<br>DART | BELVEDERE<br>SATELLITE<br>CORONET<br>CHARGER | FURY<br>POLARA<br>MONACO<br>CHRYSLER | IMPERIAL |
|----------|---|-----|---------|------------------------------|--|--------------------------------------|----------|
| 22-01-5  | WHEEL, 13 x 4.50  |     | 5       | 2534 167                     |  |                                      |          |
|          | 14 x 4.50   |     | 5       | 2660 308                     |  |                                      |          |
|          | 14 x 5.50   |     | 5       | 2660 312                     |  |                                      |          |
|          | 14 x 5.50   |     | 5       | -----                        | 2298 523                                     |                                      |          |
|          | 14 x 5.00, except Sta. Wgn.                                   |     | 5       | -----                        | 2401 417                                     |                                      |          |
|          | 14 x 5.00, P, except Sta. Wgn.                                |     | 5       | -----                        | -----  | 2525 075                             |          |
|          | 15 x 5.50   |     | 5       | -----                        | B2823 858                                    |                                      |          |
|          | 14 x 5.50, Charger, P, D, C1, C2, except Sta. Wgn., Deep Dish |     | 5       | -----                        | 2534 702                                     | 2534 702                             |          |
|          | 14 x 6.00   |     | 5       | -----                        | -----  | 2534 706                             |          |
|          | 14 x 6.50, C1, Sta. Wgn.                                      |     | 5       | -----                        | -----  | B2823 780                            |          |
|          | 15 x 6.00, except Police and Taxi                             |     | 5       | -----                        | -----  | B2823 868                            |          |
|          | 15 x 5.50   |     | 5       | -----                        | 2823 858                                     |                                      |          |
|          | 15 x 6.00, Police and Taxi                                    |     | 5       | -----                        | -----  | *2823 863                            |          |
|          | 15 x 6.00   |     | 5       | -----                        | -----  | -----                                | 2534 842 |
|          | 14 x 5.50, Chrome Plated                                      |     | 4       | -----                        | 2823 840                                     |                                      |          |
|          | 14 x 6.00, Chrome Plated, except Sta. Wgn.                    |     | 4       | -----                        | -----  | 2823 841                             |          |
| 22-01-42 | COVERS, Wheel   |     |         |                              |  |                                      |          |
|          | V, B, 13" Wheel   |     | 4       | 2781 550                     |  |                                      |          |
|          | V1-H, V2-H, B, 14" Wheel                                      |     | 4       | 2823 014                     |  |                                      |          |
|          | L, 13" Wheel  |     | 4       | 2823 016                     |  |                                      |          |
|          | L, W, "Dodge Division", 14" Wheel                             |     | 4       | 2823 024                     | 2823 024                                     |                                      |          |
|          | L, W, D, Simulated Mag.                                       |     | 4       | 2880 618                     | 2880 618                                     | 2880 618                             |          |
|          | V, B, R, except Satellite, 14" Wheel                          |     | 4       | 2823 010                     | 2823 010                                     |                                      |          |
|          | W2-P Charger  |     | 4       | -----                        | 2880 621                                     |                                      |          |
|          | R, P  |     | 4       | -----                        | 2823 028                                     | 2823 028                             |          |
|          | P, D, C, 15" Wheels   |     | 4       | -----                        | -----  | 2823 059                             |          |
|          | P, Spoked Ring and Dome Type                                  |     | 4       | -----                        | -----  | 2660 971                             |          |
|          | P, 1 Piece - Custom   |     | 4       | -----                        | -----  | 2823 029                             |          |
|          | D2-L, D2-M, D2-H, D2-P, Spinner Type, for Deep Dish Wheel     |     | 4       | -----                        | -----  | 2880 621                             |          |
|          | P, D, C, use w/Disc Brakes                                    |     | 4       | -----                        | -----  | 2823 058                             |          |
|          | D2-L, D2-M, D2-H, D2-P, Dome Type                             |     | 4       | -----                        | -----  | 2823 004                             |          |
|          | C1-E, C1-L, except Sta. Wgn. "Chrysler"                       |     | 4       | -----                        | -----  | 2823 038                             |          |
|          | C1, Sta. Wgn., C3   |     | 4       | -----                        | -----  | 2823 046                             |          |
|          | C1 except Sta. Wgn., C3                                       |     | 4       | -----                        | -----  | 2823 055                             |          |
|          | C2, Spinner Type, for Deep Dish Wheel                         |     | 4       | -----                        | -----  | 2768 002                             |          |
|          | COVER, Simulated Mag. Wheel, D, 14" Wheel                     |     | 4       | -----                        | -----  | 2808 349                             |          |
|          | C2-M "300"  |     | 4       | -----                        | -----  | 2823 045                             |          |
|          | Y   |     | 4       | -----                        | -----  | -----                                | 2823 049 |

TYPE LETTERS Indicate: V - Valiant R - Belvedere P - Plymouth C - Chrysler  
 B - Barracuda L - Dart W - Coronet D - Dodge Y - Imperial

★ Indicates use as required. Numerals in parentheses ( ) refer to notes. Printed in U.S.A.  
 B Indicates parts not listed in any previous parts book. January 1968, Supersedes March 1967.

\* Indicates change or addition.

# 1967 PASSENGER CAR PARTS CATALOG

WHEELS

| CODE                           | PART NAME AND DESCRIPTION   | CYL | PER CAR | VALIANT<br>BARRACUDA<br>DART | BELVEDERE<br>SATELLITE<br>CORONET<br>CHARGER | FURY<br>POLARA<br>MONACO<br>CHRYSLER | IMPERIAL |
|--------------------------------|---|-----|---------|------------------------------|--|--------------------------------------|----------|
| <b>22-01-0 WHEELS - Cont'd</b> |   |     |         |                              |  |                                      |          |
| 22-01-43                       | APPLIQUE, use w/2880621 Cover, W2-P<br>Charger, D2 . . . . .                              | 4   | ----    | ----                         | 2880 619                                     | 2880 619                             |          |
|                                | HUB, use w/2660971 Cover, P . . . . .   | 4   | ----    | ----                         | ----   | 2660 991                             |          |
|                                | APPLIQUE, use w/2823055 Cover, C1, C3 . . . . .   | 4   | ----    | ----                         | ----   | 2660 995                             |          |
|                                | HUB, use w/2823055 Cover, C1, C3 . . . . .  | 4   | ----    | ----                         | ----   | 2660 981                             |          |
|                                | MEDALLION, use w/2823055 Cover, C1, C3 . . . . .  | 4   | ----    | ----                         | ----   | 2823 054                             |          |
|                                | APPLIQUE, use w/2768002 Cover, C2 . . . . .   | 4   | ----    | ----                         | ----   | 2660 977                             |          |
|                                | HUB, use w/2768002 Cover, C2 . . . . .  | 4   | ----    | ----                         | ----   | 2768 001                             |          |
|                                | SPINNER, use w/2768002 Cover, C2 . . . . .  | 4   | ----    | ----                         | ----   | 2660 975                             |          |
|                                | APPLIQUE, use w/2823045 Cover, C2 . . . . .   | 4   | ----    | ----                         | ----   | 2823 041                             |          |
|                                | MEDALLION, use w/2823045 Cover, C2 . . . . .  | 4   | ----    | ----                         | ----   | 2823 042                             |          |
|                                | MEDALLION, use w/2823049 Cover, Y . . . . .   | 4   | ----    | ----                         | ----   | ----                                 | 2534 220 |
|                                | RING, Inner, use w/2823 049 Cover, Y . . . . .  | 4   | ----    | ----                         | ----   | ----                                 | 2534 219 |
| 22-01-46                       | EXTENSION PACKAGE, Valve Stem 1/2" lgh.<br>3/4" lgh. . . . .                              | 1   | ----    | 2660 315                     | 2660 315                                     | 2660 315                             |          |
|                                | 1 1/4" . . . . .  | 1   | ----    | ----                         | *2401 840                                    | 2401 840                             |          |
|                                | 1 1/2" lgh. . . . .   | 1   | ----    | ----                         | ----   | *2530 155                            | 2401 841 |
| 22-01-49                       | RETAINER, use w/2823842 Dome . . . . .  | 4   | ----    | ----                         | 2823 845                                     | 2823 845                             | 2534 223 |
|                                | RETAINER, use w/2823054 Medallion . . . . .   | 4   | ----    | ----                         | ----   | 2768 004                             |          |
| 22-01-51                       | DOMES, use w/2823024 Cover, L, W . . . . .  | 4   | ----    | 2823 023                     | 2823 023                                     | ----                                 |          |
|                                | DOMES, use w/2823004 Cover . . . . .  | 4   | ----    | ----                         | ----   | 2823 002                             |          |
|                                | DOMES, use w/2823840 and 2823841 Wheel . . . . .  | 4   | ----    | ----                         | 2823 842                                     | 2823 842                             |          |
|                                | DOMES, use w/2880621 Cover, W2-P, D2 . . . . .  | 4   | ----    | ----                         | 2880 619                                     | 2880 619                             |          |
| 22-01-56                       | SPACER, use w/2781 546 Cover, P, D, C . . . . .   | 4   | ----    | ----                         | ----   | 2781 593                             |          |
|                                | Use w/2823 045 Cover, C2-M . . . . .  | 4   | ----    | ----                         | ----   | 2823 044                             |          |
|                                | Use w/2823 055 Cover . . . . .  | 4   | ----    | ----                         | ----   | 2781 533                             |          |
| 22-01-58                       | SPRING, Cover Dome and Inner Ring Retention,<br>use w/2823 004 and 2823 049 Covers D2, Y3 | 4   | ----    | ----                         | ----   | 2409 840                             | 2409 840 |

## 22-03-0 FRONT HUB AND BRAKE DRUM

Note: EXAMPLE - Brake Size 9" x 2 1/2"  
 First Number (9") refers to diameter of Drum  
 Second Number (2 1/2") refers to width of Brake Lining

|         |   |   |   |            |             |            |  |
|---------|---|---|---|------------|-------------|------------|--|
| 22-03-1 | HUB and BRAKE DRUM,<br>9" Brakes, Steel Encased . . . . .                                   | 6 | 1 | 2267 080-1 |             |            |  |
|         | 9" Brakes, Cast Iron, w/Steel Back . . . . .  | 6 | 1 | 2260 534-5 |             |            |  |
|         | 10" x 2 1/4" . . . . .  |   | 1 | 2534 750-1 |             |            |  |
|         | HUB and BRAKE DISC . . . . .  |   | 1 | 2660 296-7 |             |            |  |
|         | HUB and BRAKE DRUM, 10" x 2 1/2" Brakes,<br>Kelsey-Hayes Housing, Stamped KH-E223 . . . . . |   | 1 | ----       | 2409 858-9  |            |  |
|         | 10" x 2 1/2" Brakes, Budd Housing, Stamped<br>CB51 . . . . .                                |   | 1 | ----       | 2460 610-1  |            |  |
|         | 10" x 2 1/2" Brakes, Motor Wheel Housing,<br>Stamped 35386 . . . . .                        |   | 1 | ----       | 2405 828-9  |            |  |
|         | 11" x 3" Brakes, w/383, 426 and 440<br>cu. in. Eng. . . . .                                 | 8 | 1 | ----       | *2266 390-1 |            |  |
|         | 11" x 2 3/4" Brakes, P, Budd Housing,<br>Stamped B . . . . .                                |   | 1 | ----       | ----        | 2530 314-5 |  |
|         | 11" x 2 3/4" Brakes, P, Kelsey-Hayes<br>Housing, Stamped K-H . . . . .                      |   | 1 | ----       | ----        | 2800 500-1 |  |
|         | 11" x 2 3/4" Brakes, P, Motor Wheel<br>Housing, Stamped MW . . . . .                        |   | 1 | ----       | ----        | 2781 570-1 |  |

TYPE LETTERS indicate: V - Valiant R - Belvedere P - Plymouth C - Chrysler  
 B - Barracuda L - Dart W - Coronet D - Dodge Y - Imperial

\* Indicates use as required. Numerals in parentheses ( ) refer to notes. Printed in U.S.A.  
 B Indicates parts not listed in any previous parts book. \* Indicates change or addition.

January 1968, Supersedes March 1967.